

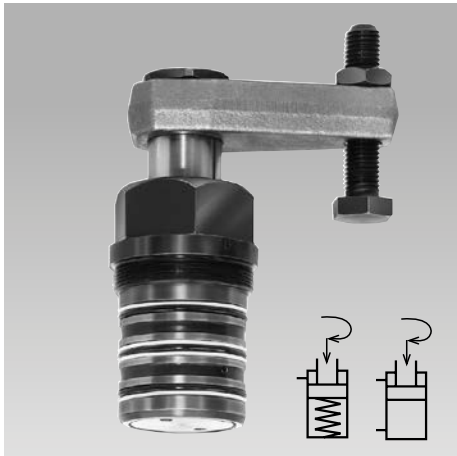

Swing Clamps with Overload Protection Device

threaded-body type, single and double acting,
 max. operating pressure 500 bar



Application

Hydraulic swing clamps are used for clamping of workpieces when it is essential to keep the clamping area free of straps and clamping components for unrestricted workpiece loading and unloading.

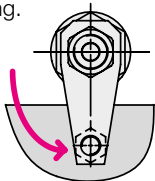

Clamping arms and strap type clamps are fastened to the piston rod by means of a taper shank and socket connection.

Function

This hydraulic clamping element is a pull-type cylinder where a part of the total stroke is used to swing the piston.

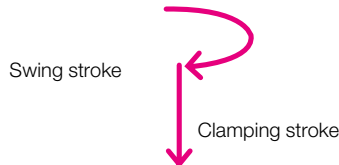

Overload protection device

An integrated mechanical overload protection device prevents damage to the swing mechanism when striking an object within the 90° rotation, clamping or unclamping alike, or in case of incorrect mounting of the clamping arm.

Metallic wiper
 optional

Option:

metallic wiper

In addition to the FKM wiper all double-acting swing clamps can be equipped with a metallic wiper.

Part no.: Add only letter "M" to the part number of the swing clamp without metallic wiper.

Example of ordering:

Swing clamp 1893 101

with metallic wiper: **1893 101M**

Version

The units are available in three standard sizes, and for each size three versions of standard clamping arms are available (see accessories, page 4). Mounting of these clamping arms at any angle within 360°.

All units are equipped with piston rod wipers.

Materials

By nitrating piston and housing, wear is reduced and protection against corrosion increased.

Piston material: High alloy steel

Cylinder body: Free-cutting steel

Important notes

Operating conditions, tolerances and other data see data sheet A 0.100.

It is absolutely necessary to follow the instructions for venting of the spring area on data sheet G 0.110.

Swing direction

The units are available with clockwise and counterclockwise swing motion or without swing motion (0°).

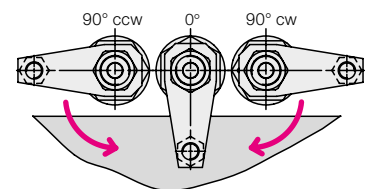

Standard swing angles are 45°, 60°, and 90° ±2°.

Special angles on request.

Other variants, as e.g. versions with metallic wiper on request.

0°-Version

Use as pure pull-type cylinder with a piston which is secured against torsion and which allows eccentric load as per clamping force diagram.

Application example

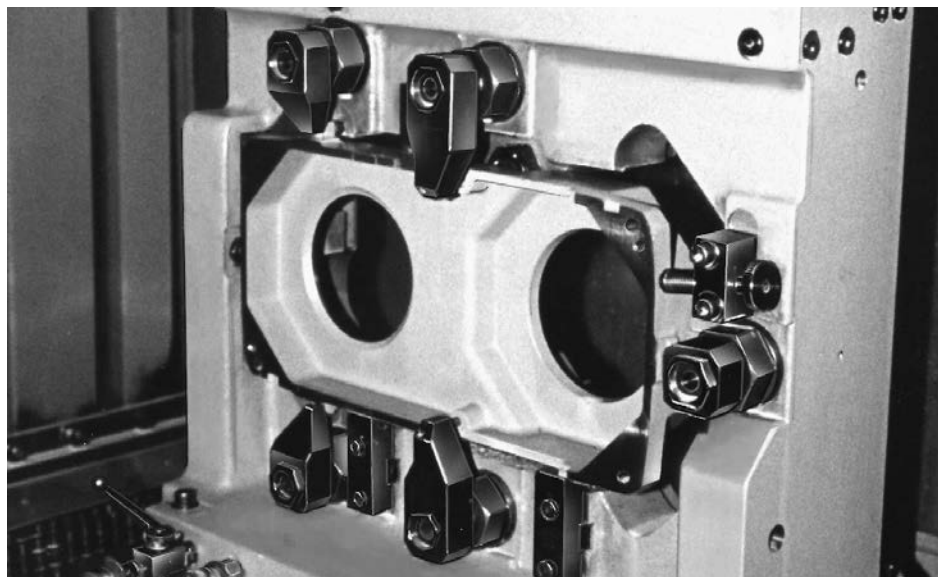

Dimensions Technical Data

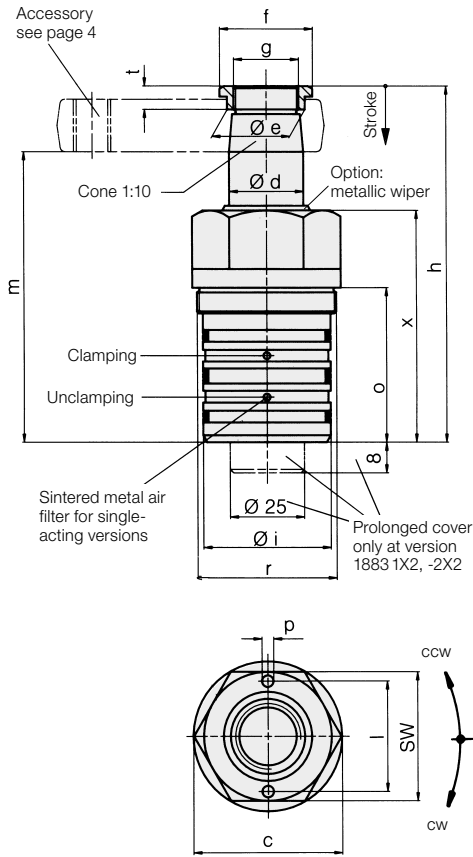

Oil volume / stroke	[cm ³]	3.2	10.0	27.7
Oil volume / return stroke	[cm ³]	8.8	27.7	74.8
Total stroke	[mm]	18	22	24
Swing stroke	[mm]	7	8	9
Clamping stroke	[mm]	11	14	15
Operating pressure to swing min.	[bar]	30	30	30
Max. oil flow rate*	[cm ³ /s]	3.2	10.0	27.7
c	[mm]	52	64	100
Ø d	[mm]	20	32	50
Ø e	[mm]	23.5	33.5	55.5
f	[mm]	30	40	68
g	[mm]	M 18x1.5	M 28x1.5	M 45x1.5
h	[mm]	112	152	182
Ø i f7	[mm]	42	55	85
Ø k H7	[mm]	42	55	85
l	[mm]	-	-	80
m	[mm]	91-1	124-1	142-1 (145-1)◇
n	[mm]	24	29	41
o	[mm]	53	66	96
Ø p / deep	[mm]	-	-	8/9
Ø q max.	[mm]	5	5	6
r	[mm]	M 45x1.5	M 60x1.5	M 90x2
s	[mm]	41	46.5	64
t	[mm]	9	10	12
Ø u	[mm]	44	57	87
v	[mm]	37	41.5	59
w	[mm]	20	24	36
x	[mm]	70	99	116
y	[mm]	10.5	12.5	20.5
z	[mm]	8	10	10
SW	[mm]	46	55	95

Manifold mounting hole

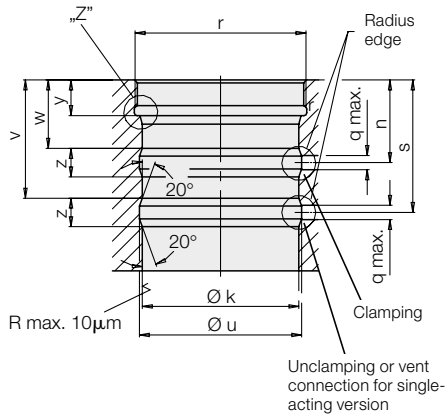

Part no., single acting

Swing direction cw	1883 102	1885 102	1887 102
Swing direction ccw	1883 202	1885 202	1887 202

Part no., double acting

Swing direction cw	1893 101	1895 101	1897 101
Swing direction ccw	1893 201	1895 201	1897 201

Seal kit for external seals	0131 524	0131 526	0131 528
-----------------------------	-----------------	-----------------	-----------------

Other swing angles:

Swing angle	Part no.
90°	18XX X0X
60°	18XX X2X
45°	18XX X3X
0°	18XX 14X

◇ (145-1) for clamping arm 0354 004

* See page 3:
Max. oil flow rate

Option metallic wiper
for double-acting swing clamps
Partn no.: 189XXXXM

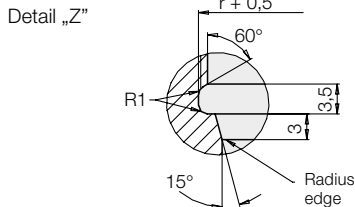

Effective clamping force F_{Sp} as function of operating pressure p

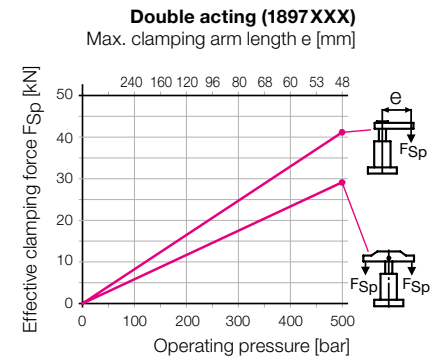
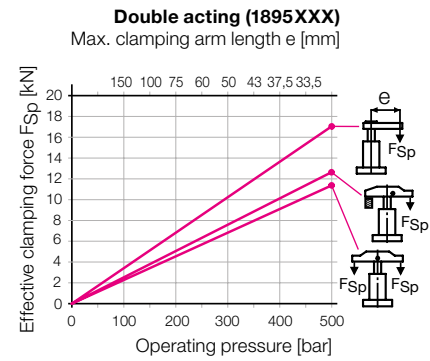
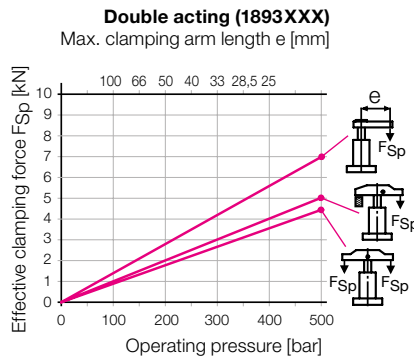
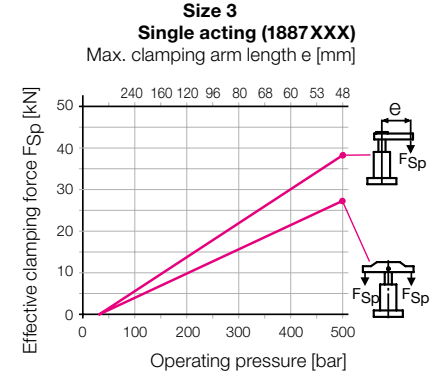
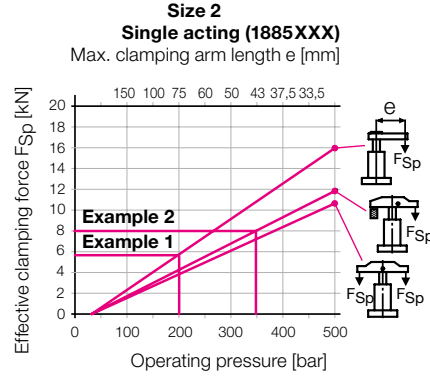
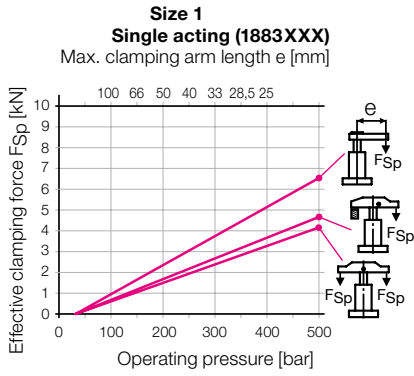

Note:
The clamping force of single-acting swing clamps is reduced by the opposite-directed spring return force. For this reason the clamping force is slightly lower than that of double-acting swing clamps.

Example 1: 1885 102 single acting.
An operating pressure p of 200 bar in connection with standard clamping arm 0354003 of max. arm length $L = 75$ mm results in an effective clamping force F_{Sp} of 5.8 kN.

Example 2: 1885 102 single acting.
For a desired effective clamping force F_{Sp} of 8 kN and use of a swing clamp 1885 102 with a standard clamping strap 0354002 an operating pressure p of 345 bar is required.

Important notes

1. Danger of injury

Hydraulic clamping elements can generate considerable forces. Due to the 90° swing motion, the exact clamping and unclamping position cannot be determined in advance. Considerable injuries can be caused to fingers in the effective area of the clamping arm. Remedy: protection device with electrical locking.

2. Maximum oil flow rate

In case of the maximum oil flow rate as per chart the shortest possible clamping time is 1 second. If the flow rate of the pump divided by the number of swing clamps is higher than the indicated value in the chart, the flow rate has to be throttled to avoid snapping out of the overload protection device. In the case that the mounting position is not vertical and/or heavy clamping arms are used, the flow rate has to be further reduced, if required. Throttling has to be made in the oil supply line to the swing clamp to rule out a possible pressure intensification. Use only flow control check valves which allow oil return from the swing clamps without any impediments, as e.g. the flow-control swivel banjo coupling 9208129 on page C 2.9501. During unclamping the maximum oil flow rate can be 2.8 higher than the indicated value in the chart, because the piston area is correspondingly bigger.

3. Unimpeded swing motion

The swing motion must not be impeded and the clamping arm may only contact the workpiece after completion of the swing stroke.

4. Clamping arm assembly

In case of this threaded-body type the clamping arm can only be fixed, after firm screwing in of the housing, since the final position cannot be determined in advance. When tightening and untightening the fixing screw, the clamping arm has to be backed up to avoid the introduction of moments to the piston rod.

5. Adjustment of contact bolt

The contact bolt may only contact the workpiece after completion of the swing motion. When tightening and untightening the fixing screw, the clamping arm has to be backed up (see 4.).

6. Special clamping arms

When using special clamping arms with other lengths, the corresponding operating pressures as shown in the clamping force diagram must not be exceeded. If longer clamping arms will be used, not only the operating pressure but also the flow rate have to be reduced (see 2.).

7. Venting of spring area

The spring area of single-acting swing clamps has to be vented to avoid problems in functioning. A sintered metal air filter avoids penetration of contaminations. If there is a possibility that cutting lubricants and coolants penetrate through the sintered metal air filter into the cylinder's interior, a vent hose has to be connected and be placed in a protected position (see data sheet G 0.110).

8. Bleeding

Air in the oil prolongs the clamping time considerably and leads to function problems. Therefore bleeding has to be effected during start up. The threaded-body swing clamp has no possibility for bleeding at the element itself. Remedy: plug the oil channels in the fixture body at the end. If required, loosen the plugs carefully and pump at low oil pressure until bubblefree oil comes out. Retighten the plugs.

Accessories

Dimensions
for special
clamping arms

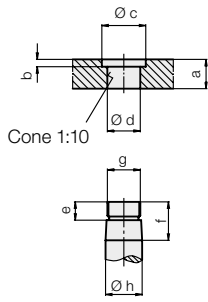

Swing clamp	a	b	Øc	Ød ^{+0,10 +0,05}	e	f	g	Øh ^{f7}
18X3XXX	16	4	24	19.8	10	21	M 18x1,5	20
18X5XXX	23	5	34	31.8	12	28	M 28x1,5	32
18X7XXX	34	6	56	49.8	13	40	M 45x1,5	50

Clamping arm,
max. 300 bar

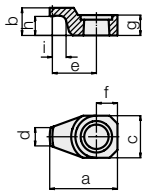

Swing clamp	a	b	c	d	e	f	g	h	i	Weight [kg]	Part no.
18X3XXX	51.5	21	32	14	33.5	16	15.5	14.5	7	0.11	3548238
18X5XXX	76	28	46	25	50	23	22.5	19	7	0.30	3548236
18X7XXX	123	40	75	39	82.5	37.5	34	27	8	1.30	3548302

Material: 42CrMo4

Clamping arm
assembly,
complete,
max. 200 bar

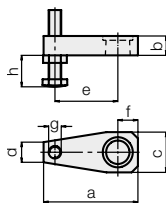

Swing clamp	a	b	c	d	e	f	g	h max.	h min.	i	Weight [kg]	Part no.
with thread												
18X3XXX	75	16	32	16	50	16	M10	64	6	6	0.2	0354001
18X5XXX	115	23	48	22	75	25	M16	79	9	9	0.7	0354003
18X7XXX	178	34	78	40	120	40	M20	98	12	12	2.55	0354005
without thread												
Swing clamp	a	b	c	d	f						Weight [kg]	Part no.
18X3XXX	75	16	32	16	16						0.18	3921016
18X5XXX	115	23	48	22	25						0.65	3921017
18X7XXX	178	34	78	40	40						2.3	3921018

Material: 42CrMo4

Clamping strap
assembly,
complete,
with carrier,
max. 500 bar

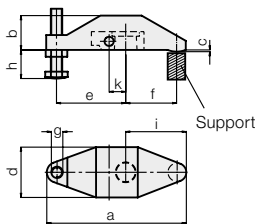

Swing clamp	a	b	c	d	e	f	g	h max.	h min.	i	k	Weight [kg]	Part no.
18X3XXX	122	30	1.5	44	60	45	M10	64	6	53	14.5	0.57	0354000
18X5XXX	185	45	2	58.5	83	75	M16	79	9	87	21	1.58	0354002

Material: GGG-40

Carrier for special
clamping strap

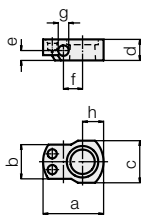

Swing clamp	a	b	c	d	e	f	g ^{H7}	h	Weight [kg]	Part no.
18X3XXX	46	26	32	16	7.5	14.5	8	16	0.08	3542093
18X5XXX	59	32	40	23	13	21	10	22	0.16	3542094
18X7XXX	90	56	68	34	21	33	14	36	0.65	3542096

Material: 42CrMo4

Double clamping
arm assembly,
complete,
with carrier,
max. 500 bar

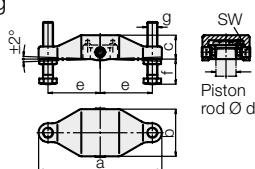

Swing clamp	a	b	c	Ød	e	f min.	f max.	g	SW	Weight [kg]	Part no.
18X3XXX	138	59	28.5	20	60	10	64	M 10	5	0.83	0354131
18X5XXX	196	75	38	32	83	15	79	M 16	8	2.11	0354132
18X7XXX	236	105	56	50	100	19	98	M 20	8	5.24	0354134

Material: GGG-40

Carrier, complete
with threaded
bolt and spring
clamping
elements

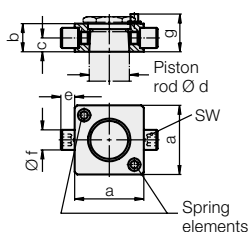

Swing clamp	a ^{±0,1}	b	c	Ød	e	Øf ^{g6}	g*	SW	Part no.
18X3XXX	43	16	7.5	20	9	10	21.5	5	0354141
18X5XXX	55	23	11	32	11	16	29	8	0354142
18X7XXX	77	34	17	50	15	20	41	8	0354144

* Stop surface for spring elements

Material: 42CrMo4