

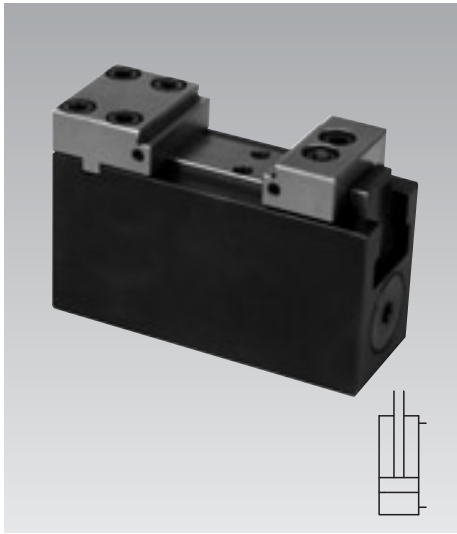

Fixture Clamp with Fixed Jaw

max. clamping force 9.5 kN, jaw width 40 mm,
double acting, max. operating pressure 250 bar



Advantages

- Very compact design
- High rigidity and precision
- Strokes 5 and 30 mm
- Double-acting function
- Fixtures without tubes possible
- Exchangeable jaws
- Pneumatic contact or seat control in the fixed jaw possible
- Good swarf protection
- Port for central lubrication
- Mounting position: variable

Function

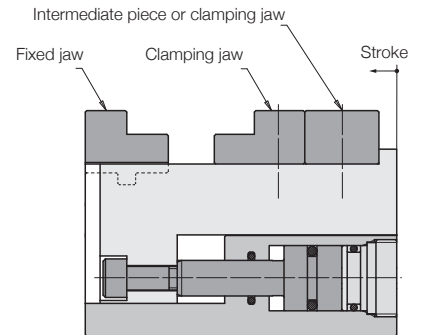

Application

The fixture clamps are used for machining of dimensionally stable workpieces in single or multiple clamping fixtures.

Due to their compact design they can be arranged in a very limited space.

Fixture clamps are especially suitable for series manufacturing in automated mode.

The double-acting cylinder function combined with central lubrication and good swarf protection guarantees a high process safety.

Fixing from above

with accessory adaptor plate
Drilled channels

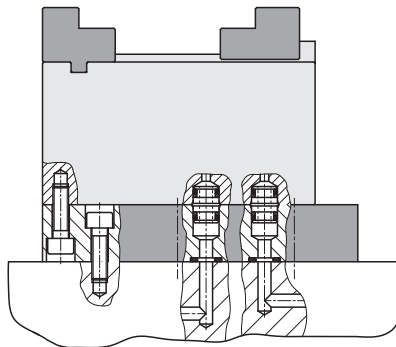

Fixing from below

Drilled channels

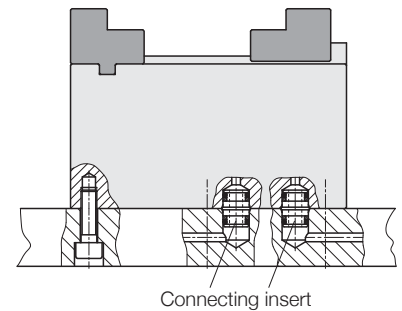

Description

The fixture clamp with fixed jaw consists of a very small basic body with integrated hydraulic cylinder which actuates the movable jaw.

All threads and ports are at the bottom to allow a space-saving arrangement of several clamping points in a very limited space.

If fixing from below is not possible an adaptor plate for manifold mounting or tube connection is available. As accessory also blanks of clamping jaws are available for adaptation to the workpiece contour.

The fixed jaw can be equipped with a pneumatic seat control.

Fitting connection

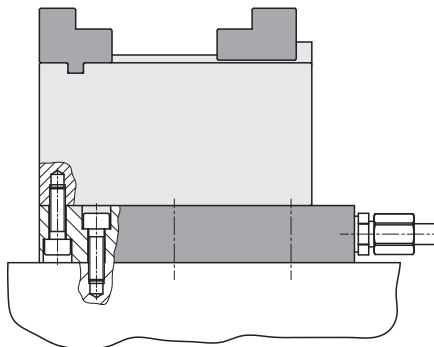

Accessories

Fixed jaw, clamping jaws and adaptor plate are not included in the delivery of the fixture clamp and have to be ordered separately as accessory.

Application example

Clamping fixture for a pedal of a freight vehicle.

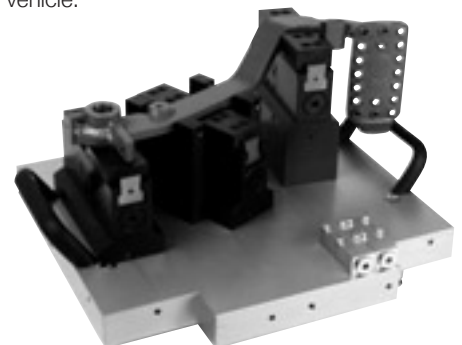

Important notes

The fixture clamp is only suitable for exterior clamping.

Lubricate at the latest after 500 clamping cycles the clamping slide via the central lubrication.

Never use the complete clamping stroke to guarantee safe clamping of the workpiece.

Max. operating temperature 80 °C.

Operating conditions and other data see data sheet A 0.100.

Clamping stroke 5 mm

Technical data • Accessories • Dimensions

Clamping stroke 5 mm: Part-no. 4413-001

Technical characteristics

Clamping force max.	[kN]	9.5
Clamping stroke	[mm]	5
Jaw width	[mm]	40
Max. flow rate	[cm ³ /s]	25
Stroke volume		
Clamping	[cm ³]	2.5
Unclamping	[cm ³]	1.9
Weight	[kg]	approx. 1.66

Adaptor plate (accessory)

Weight [kg] approx. 1.3
Part-no. 0441-300

Clamping force diagram

(Height of the clamping jaw 15 mm)

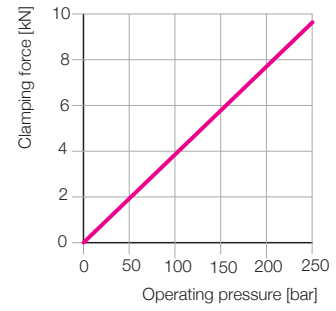

Accessory: adaptor plate
View from below

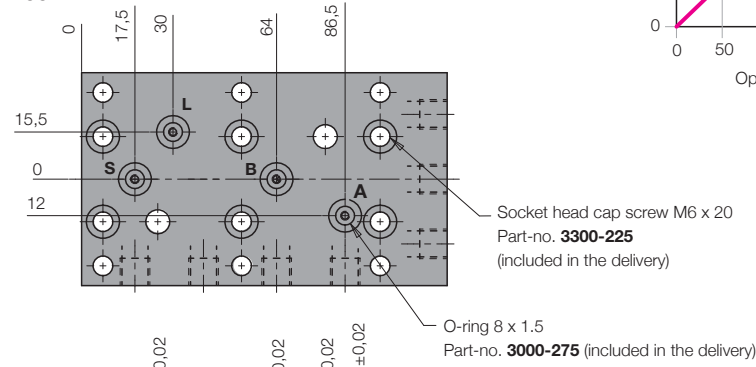

Clamping and unclamping

each Ø10 H7 x 7 deep for connecting insert **9210-132** (included in the delivery), see also page F 9.300

Seat control and central lubrication with O-ring **3001-842** (5x1 mm) (included in the delivery)

- A** = Clamping
- B** = Unclamping
- S** = Central lubrication
- L** = Air for seat control

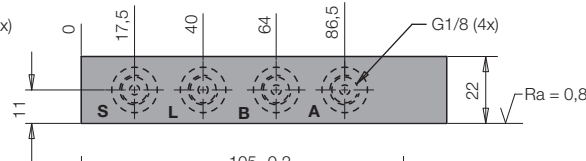
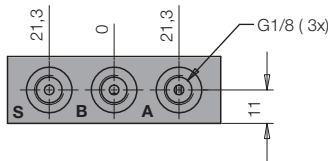
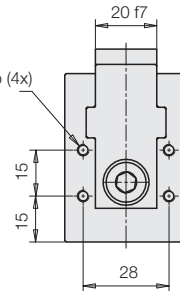
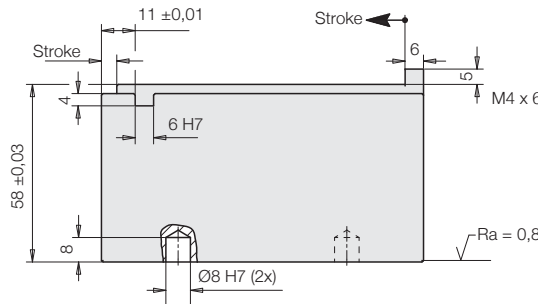
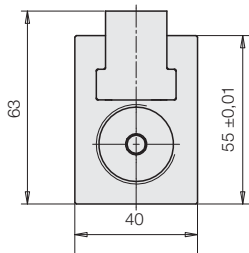
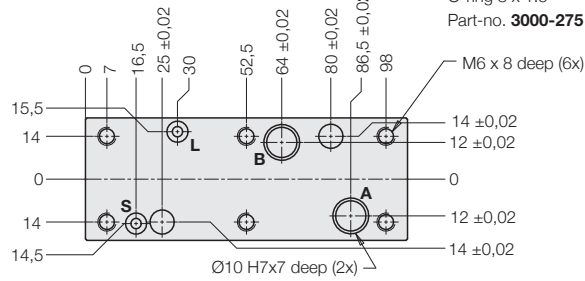

Accessory: adaptor plate
Side views

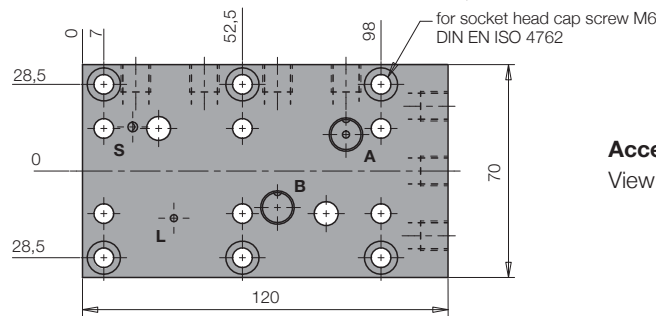
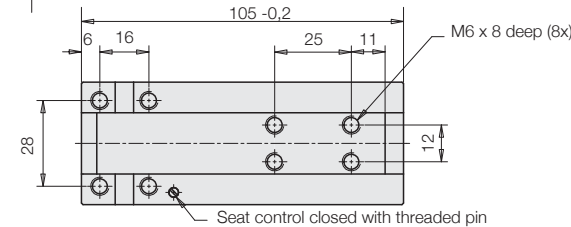

Accessory: adaptor plate
View from above

Clamping stroke 30 mm

Technical data • Accessories • Dimensions

Clamping stroke 30 mm: Part-no. 4413-031

Technical characteristics

Clamping force max.	[kN]	9.5
Clamping stroke	[mm]	30
Jaw width	[mm]	40
Max. flow rate	[cm ³ /s]	25
Stroke volume		
Clamping	[cm ³]	15
Unclamping	[cm ³]	12
Weight	[kg]	approx. 2.24

Adaptor plate (accessory)

Weight	[kg]	approx. 1.8
Part-no.		0441-303

Clamping force diagram

(Height of the clamping jaw 15 mm)

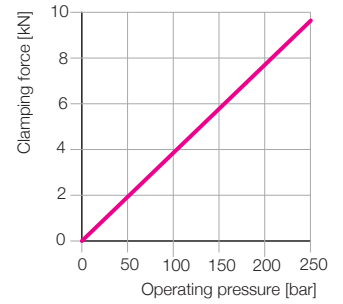

Accessory: adaptor plate

View from below

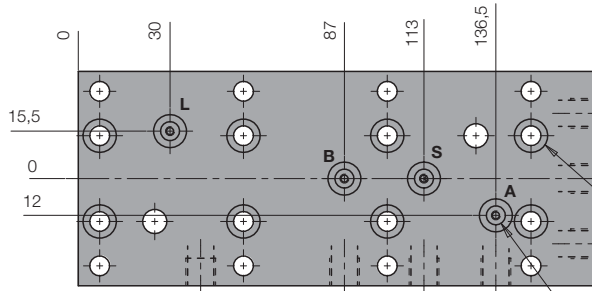

Socket head cap screw M6 x 20
Part-no. **3300-225**
(included in the delivery)

O-ring 8 x 1.5
Part-no. **3000-275** (included in the delivery)

- A** = Clamping
- B** = Unclamping
- S** = Central lubrication
- L** = Air for seat control

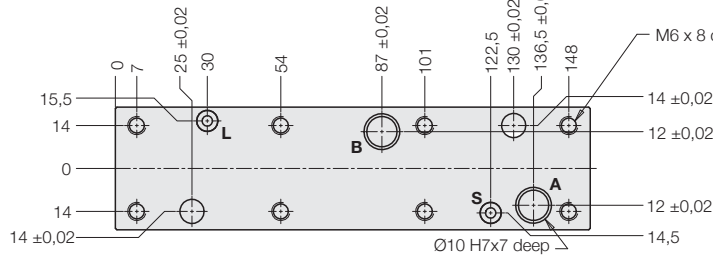

Clamping and unclamping
each Ø10 H7 x 7 deep for
connecting insert **9210-132**
(included in the delivery),
see also page F 9.300

Seat control and central lubrication
with O-ring **3001-842** (5x1 mm)
(included in the delivery)

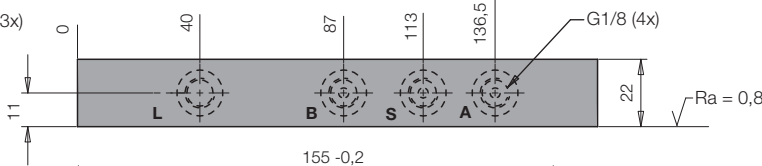
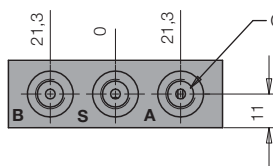
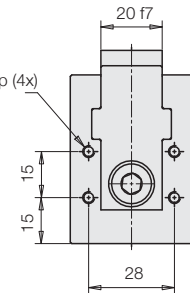
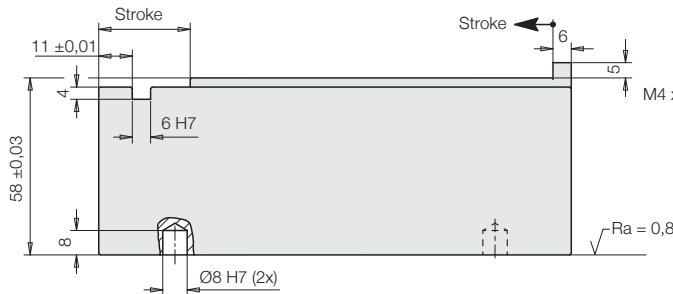
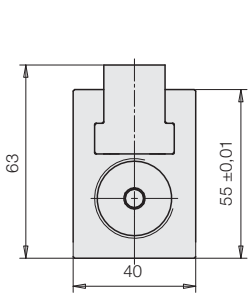

**Accessory:
adaptor plate**
Side views

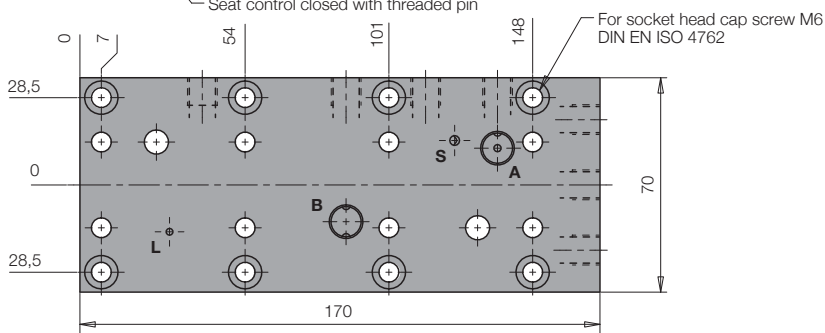
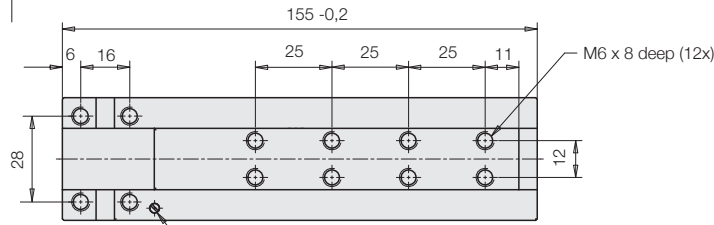

**Accessory:
adaptor plate**
View from above

Accessory - clamping jaws

Versions: Clamping jaw blanks
 Material: 16 MnCr5 smooth

Clamping jaw: Part-no. 3548-070

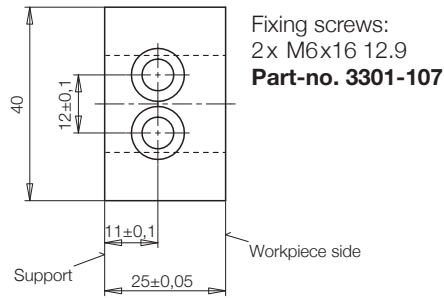
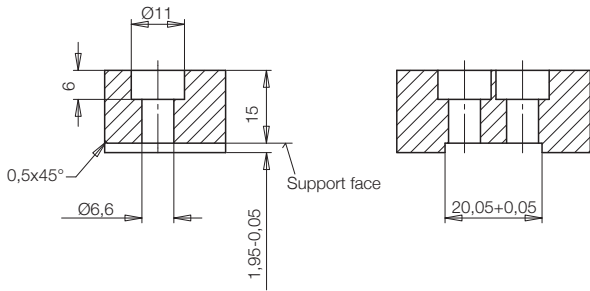

Fixed jaw: Part-no. 3548-071

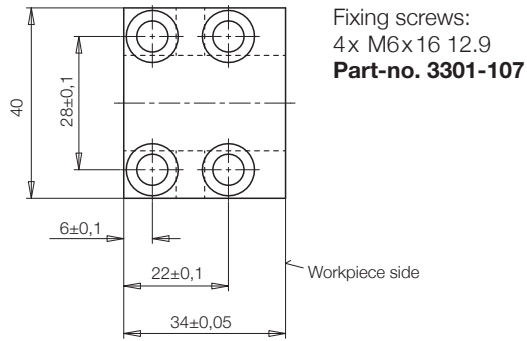
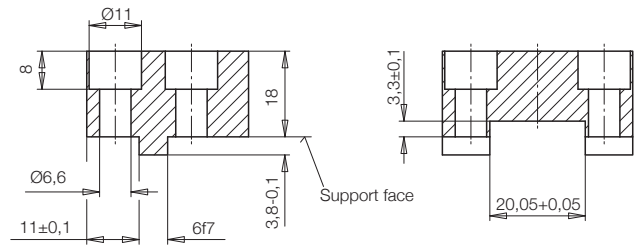

Self-made clamping jaws

Clamping jaws and fixed jaws are manufactured according to the contour of the workpiece to be clamped.

The max. height of the clamping jaw X at 250 bar operating pressure is indicated in the below chart.

If the operating pressure is lower, the clamping jaws and the fix jaws can be designed higher as per the below diagram.

Important note

The clamping jaws must always be supported by the provided support, since the fixing screws are not in the position to compensate the generated clamping forces.

Max. height of the clamping jaws X at max. operating pressure of 250 bar

Fixing screws for clamping jaws	M6x16 - 12.9
X [mm] with 2 screws	15
X [mm] with 4 screws	36

Fixing of the clamping jaws

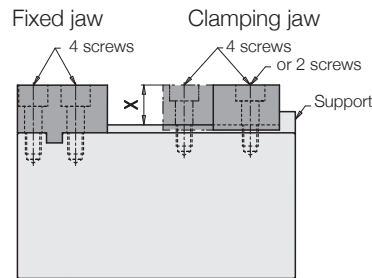

Max. height of the clamping jaw X as a function of the operating pressure

